

# Uponor underjordisk ventilationssystem - UVS

Prisliste januar 2019, ekskl. moms / ret til ændringer forbeholdes

## ø200-500:

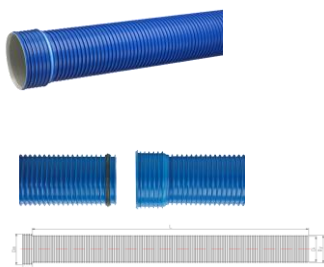

## ø600-1000:

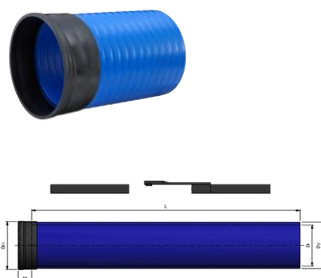

## ø1200-2500:

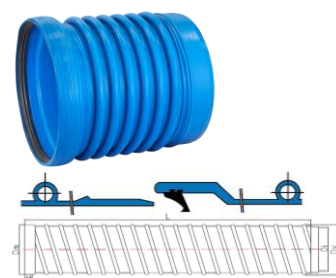

## Rør

Der fås andre længder end 6 m for ø600-ø2500

| Dimension<br>mm | D<br>mm | Muffedybde<br>mm | Muffe udv.<br>mm | Uponor<br>nr. | VVS-<br>nr. | Vare-<br>gruppe | Pris<br>Kr./stk. |
|-----------------|---------|------------------|------------------|---------------|-------------|-----------------|------------------|
| 175/200         | 200     | 119              | 224              | 1051446       | 353106200   | F1-1-1          | 1.228,00         |
| 220/250         | 250     | 133              | 277              | 1051447       | 353106250   | F1-1-1          | 1.774,00         |
| 277/315         | 315     | 150              | 346              | 1051448       | 353106315   | F1-1-1          | 2.512,00         |
| 396/450         | 400     | 170              | 488              | 1051449       | 353106405   | F1-1-1          | 5.283,00         |
| 492/560         | 500     | 204              | 605              | 1051450       | 353106412   | F1-1-1          | 6.588,00         |
| 600/675         | 600     | 220              | 723              | 1000747       | 353106415   | F1-1-2          | 7.111,00         |
| 800/900         | 800     | 250              | 955              | 1000457       | 353106440   | F1-1-2          | 14.152,00        |
| 1000/1125       | 1000    | 300              | 1185             | 1000787       | 353106460   | F1-1-2          | 24.272,00        |
| 1200/1370       | 1200    | 160              | 1350             | 1051453       | 353106475   | F1-1-2          | 28.609,00        |
| 1400/1580       | 1400    | 210              | 1560             | 1054842       | 353106485   | F1-1-2          | 29.950,00        |
| 1600/1780       | 1600    | 210              | 1760             | 1051454       | 353106495   | F1-1-2          | 53.595,00        |
| 2000/2180       | 2000    | 210              | 2170             | 1051455       | 353106498   | F1-1-2          | 71.312,00        |
| 2500/2740       | 2500    | 210              | 2720             | 1051456       | 353106499   | F1-1-2          | 95.378,00        |

Materiale: PP (ø200-1000) / PE (ø1200-2500)

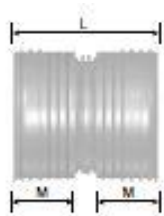

## Dobbeltmuffe

OBS! 2 stk. tætningsringe til hver del. 1 stk. tætningsring pr. rørdel.

| D<br>mm | M<br>mm | L<br>mm | Uponor<br>nr. | VVS-<br>nr. | Vare-<br>gruppe | Pris<br>Kr./stk. |
|---------|---------|---------|---------------|-------------|-----------------|------------------|
| 200     | 96      | 204     | 1051457       | 353120200   | F1-2-1          | 305,00           |
| 250     | 113     | 240     | 1051458       | 353120250   | F1-2-1          | 530,00           |
| 315     | 134     | 286     | 1051459       | 353120315   | F1-2-1          | 910,00           |
| 400     | 214     | 432     | 1051460       | 353120405   | F1-2-1          | 1.444,00         |
| 500     | 206     | 416     | 1051461       | 353120412   | F1-2-1          | 2.272,00         |



## Tætningsring

OBS! 1 stk. tætningsring pr. rørdel.

| DN rør<br>mm | Antal pr.<br>karton/palle | Uponor<br>nr. | VVS-<br>nr. | Vare-<br>gruppe | Pris<br>Kr./stk. |
|--------------|---------------------------|---------------|-------------|-----------------|------------------|
| 200          | 10/120                    | 1053656       | 192954200   | B1-2-2          | 19,00            |
| 250          | 10/1000                   | 1053657       | 192954250   | B1-2-2          | 35,00            |
| 315          | 10/600                    | 1053658       | 192954315   | B1-2-2          | 56,00            |
| 400          | 2/300                     | 1050363       | 192954450   | B1-2-2          | 165,00           |
| 500          | 2/200                     | 1050364       | 192954560   | B1-2-2          | 303,00           |

# Uponor underjordisk ventilationssystem - UVS

Prisliste januar 2019, ekskl. moms / ret til ændringer forbeholdes

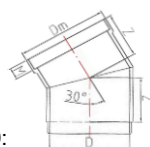
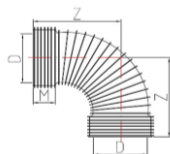

ø600-2500:

## Bøjning 30°

ø600-ø2500 produceres med monteringsører.

| D<br>mm | M<br>mm | Z<br>mm | Uponor<br>nr. | VVS-<br>nr. | Vare-<br>gruppe | Pris<br>Kr./stk. |
|---------|---------|---------|---------------|-------------|-----------------|------------------|
| 200     | 96      | 148     | 1051472       | 353127200   | F1-2-1          | 352,00           |
| 250     | 113     | 173     | 1051473       | 353127250   | F1-2-1          | 985,00           |
| 315     | 134     | 212     | 1051474       | 353127315   | F1-2-1          | 1.376,00         |
| 400     | 182     | 300     | 1051475       | 353127405   | F1-2-1          | 3.147,00         |
| 500     | 210     | 340     | 1051476       | 353127412   | F1-2-1          | 3.329,00         |
| 600     | 220     | 500     | 1000754       | 353128415   | F1-2-2          | 5.987,00         |
| 800     | 250     | 500     | 1000784       | 353128440   | F1-2-2          | 8.599,00         |
| 1000    | 300     | 600     | 1000797       | 353128460   | F1-2-2          | 12.721,00        |
| 1200    | 160     | 600     | 1051499       | 353128475   | F1-2-2          | 18.774,00        |
| 1400    | 210     | 600     | 1054832       | 353127485   | F1-2-2          | 23.442,00        |
| 1600    | 210     | 600     | 1051500       | 353128495   | F1-2-2          | 33.311,00        |
| 2000    | 210     | 600     | 1054861       | 353128498   | F1-2-2          | 38.900,00        |
| 2500    | 210     | 700     | 1054862       | 353128499   | F1-2-2          | 63.498,00        |

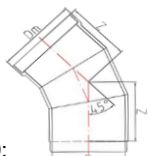
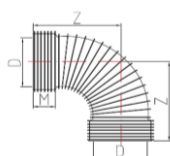

ø600-2500:

## Bøjning 45°

ø600-ø2500 produceres med monteringsører

| D<br>mm | M<br>mm | Z<br>mm | Uponor<br>nr. | VVS-<br>nr. | Vare-<br>gruppe | Pris<br>Kr./stk. |
|---------|---------|---------|---------------|-------------|-----------------|------------------|
| 200     | 96      | 163     | 1051467       | 353125200   | F1-2-1          | 368,00           |
| 250     | 113     | 196     | 1051468       | 353125250   | F1-2-1          | 985,00           |
| 315     | 134     | 240     | 1051469       | 353125315   | F1-2-1          | 1.364,00         |
| 400     | 182     | 363     | 1051470       | 353125405   | F1-2-1          | 3.101,00         |
| 500     | 210     | 410     | 1051471       | 353125412   | F1-2-1          | 4.090,00         |
| 600     | 220     | 750     | 1000749       | 353126415   | F1-2-2          | 6.952,00         |
| 800     | 250     | 800     | 1000759       | 353126440   | F1-2-2          | 9.915,00         |
| 1000    | 300     | 900     | 1000789       | 353126460   | F1-2-2          | 15.061,00        |
| 1200    | 160     | 900     | 1051503       | 353126475   | F1-2-2          | 21.500,00        |
| 1400    | 210     | 975     | 1054833       | 353125485   | F1-2-2          | 28.860,00        |
| 1600    | 210     | 975     | 1051504       | 353126495   | F1-2-2          | 41.784,00        |
| 2000    | 210     | 1050    | 1054865       | 353126498   | F1-2-2          | 52.550,00        |
| 2500    | 210     | 1250    | 1054866       | 353126499   | F1-2-2          | 84.361,00        |

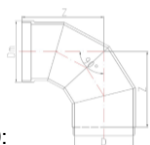
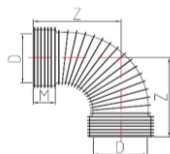

ø600-2500:

## Bøjning 90°

ø600-ø2500 produceres med monteringsører

| D<br>mm | M<br>mm | Z<br>mm | Uponor<br>nr. | VVS-<br>nr. | Vare-<br>gruppe | Pris<br>Kr./stk. |
|---------|---------|---------|---------------|-------------|-----------------|------------------|
| 200     | 96      | 182     | 1051462       | 353123200   | F1-2-1          | 682,00           |
| 250     | 113     | 216     | 1051463       | 353123250   | F1-2-1          | 1.444,00         |
| 315     | 134     | 260     | 1051464       | 353123315   | F1-2-1          | 2.193,00         |
| 400     | 182     | 626     | 1051465       | 353123405   | F1-2-1          | 3.783,00         |
| 500     | 210     | 704     | 1051466       | 353123412   | F1-2-1          | 4.771,00         |
| 600     | 220     | 950     | 1000748       | 353124415   | F1-2-2          | 8.758,00         |
| 800     | 250     | 1200    | 1000758       | 353124440   | F1-2-2          | 12.869,00        |
| 1000    | 300     | 1400    | 1000788       | 353124460   | F1-2-2          | 21.352,00        |
| 1200    | 160     | 1500    | 1051507       | 353124475   | F1-2-2          | 31.948,00        |
| 1400    | 210     | 1600    | 1054834       | 353123485   | F1-2-2          | 38.252,00        |
| 1600    | 210     | 1650    | 1051508       | 353124495   | F1-2-2          | 60.557,00        |
| 2000    | 210     | 1800    | 1054873       | 353124498   | F1-2-2          | 81.909,00        |
| 2500    | 210     | 2100    | 1054874       | 353124499   | F1-2-2          | 126.985,00       |

# Uponor underjordisk ventilationssystem - UVS

Prisliste januar 2019, ekskl. moms / ret til ændringer forbeholdes

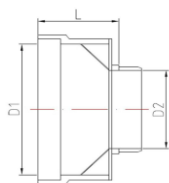

## Reduktion

Centrisk eller ekscentrisk reduktion

| D1/D2<br>mm | Uponor<br>nr. | VVS-<br>nr. | Vare-<br>gruppe | Pris<br>Kr./stk. |
|-------------|---------------|-------------|-----------------|------------------|
| 250/200     | 1051488       | 353131248   | F1-2-1          | 546,00           |
| 315/200     | 1051489       | 353131310   | F1-2-1          | 1.136,00         |
| 315/250     | 1051490       | 353131312   | F1-2-1          | 1.136,00         |
| 400/250     | 1051491       | 353131444   | F1-2-1          | 1.591,00         |
| 400/315     | 1051492       | 353131447   | F1-2-1          | 1.512,00         |
| 500/315     | 1051493       | 353131555   | F1-2-1          | 2.420,00         |
| 500/400     | 1051494       | 353131558   | F1-2-1          | 3.408,00         |
| 600/400     | 1054845       | 353131597   | F1-2-2          | 5.794,00         |
| 600/500     | 1054846       | 353131599   | F1-2-2          | 5.987,00         |
| 800/400     | 1054847       | 353131792   | F1-2-2          | 6.952,00         |
| 800/500     | 1054848       | 353131794   | F1-2-2          | 7.213,00         |
| 800/600     | 1054917       | 353131795   | F1-2-2          | 7.917,00         |
| 1000/600    | 1054889       | 353131813   | F1-2-2          | 11.460,00        |
| 1000/800    | 1054835       | 353131818   | F1-2-2          | 11.789,00        |
| 1200/800    | 1054890       | 353131856   | F1-2-2          | 13.527,00        |
| 1200/1000   | 1054891       | 353131858   | F1-2-2          | 14.357,00        |
| 1400/1000   | 1054892       |             | F1-2-2          | Efter aftale     |
| 1400/1200   | 1054893       |             | F1-2-2          | Efter aftale     |
| 1600/1200   | 1054894       |             | F1-2-2          | Efter aftale     |
| 1600/1400   | 1054836       |             | F1-2-2          | Efter aftale     |
| 2000/1400   | 1054895       |             | F1-2-2          | Efter aftale     |
| 2000/1600   | 1054837       |             | F1-2-2          | Efter aftale     |
| 2500/1600   | 1054896       |             | F1-2-2          | Efter aftale     |
| 2500/2000   | 1054897       |             | F1-2-2          | Efter aftale     |

# Uponor underjordisk ventilationssystem - UVS

Prisliste januar 2019, ekskl. moms / ret til ændringer forbeholdes



Uponor T-rør 90°

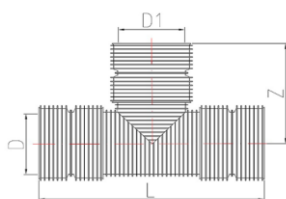

ø200-500:

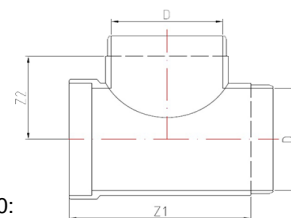

ø600-2500:

| D1/D2<br>mm | L<br>mm | Z1<br>mm | Z2<br>mm | Uponor<br>nr. | VVS-<br>nr. | Vare-<br>gruppe | Pris<br>Kr./stk. |
|-------------|---------|----------|----------|---------------|-------------|-----------------|------------------|
| 200/200     | 660     | 310      |          | 1051477       | 353133200   | F1-2-1          | 1.774,00         |
| 250/200     | 700     | 340      |          | 1054850       | 353133248   | F1-2-1          | 2.249,00         |
| 250/250     | 770     | 390      |          | 1051478       | 353133250   | F1-2-1          | 2.330,00         |
| 315/200     | 800     | 385      |          | 1054851       | 353133310   | F1-2-1          | 2.772,00         |
| 315/250     | 850     | 435      |          | 1054852       | 353133312   | F1-2-1          | 3.545,00         |
| 315/315     | 950     | 460      |          | 1051479       | 353133315   | F1-2-1          | 2.522,00         |
| 400/200     | 1100    | 465      |          | 1054853       | 353133442   | F1-2-1          | 5.407,00         |
| 200/250     | 1210    | 480      |          | 1054854       | 353133444   | F1-2-1          | 5.600,00         |
| 400/315     | 1210    | 560      |          | 1054855       | 353133447   | F1-2-1          | 5.930,00         |
| 400/400     | 1400    | 690      |          | 1051480       | 353133450   | F1-2-1          | 6.350,00         |
| 500/200     | 1050    | 540      |          | 1054856       | 353133550   | F1-2-1          | 6.509,00         |
| 500/250     | 1100    | 565      |          | 1054857       | 353133552   | F1-2-1          | 6.759,00         |
| 500/315     | 1180    | 620      |          | 1054858       | 353133555   | F1-2-1          | 6.952,00         |
| 500/400     | 1320    | 740      |          | 1054859       | 353133558   | F1-2-1          | 8.178,00         |
| 500/500     | 1450    | 730      |          | 1051481       | 353133560   | F1-2-1          | 6.815,00         |
| 600/600     |         | 1100     | 700      | 1054981       | 353134600   | F1-2-2          | 6.565,00         |
| 800/800     |         | 1300     | 830      | 1054982       | 353134800   | F1-2-2          | 20.740,00        |
| 1000/1000   |         | 1500     | 1000     | 1054983       | 353134900   | F1-2-2          | 30.393,00        |
| 1200/1200   |         | 1800     | 850      | 1054984       | 353134912   | F1-2-2          | 41.215,00        |
| 1400/1400   |         | 2000     | 950      | 1054985       | 353134914   | F1-2-2          | 52.414,00        |
| 1600/1600   |         | 2200     | 1050     | 1054986       | 353134916   | F1-2-2          | 60.728,00        |
| 2000/2000   |         | 2550     | 1250     | 1054987       | 353134920   | F1-2-2          | 108.574,00       |
| 2500/2500   |         | 3200     | 1500     | 1054988       | 353134925   | F1-2-2          | 171.425,00       |

## Uponor underjordisk ventilationssystem - UVS

Prisliste januar 2019, ekskl. moms / ret til ændringer forbeholdes

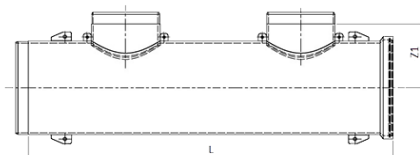

### Afgrening

90 graders afgrening påsvejses røret iht. aftale.

Hver afgrening beskrives særskilt, hvor L2-målet beregnes fra muffen, og den totale rørlængde L angives.

Der kan placeres flere afgreninger på samme rør. Iht. aftale kan andre længder produceres.

| D1/D2<br>mm | Z1<br>mm | Uponor<br>nr. | VVS-<br>nr. | Vare-<br>gruppe | Pris<br>Kr./stk. |
|-------------|----------|---------------|-------------|-----------------|------------------|
| 600/315     | 570      | 1054902       | 353133594   | F1-2-2          | 4.192,00         |
| 600/400     | 530      | 1054838       | 353133597   | F1-2-2          | 5.612,00         |
| 600/500     | 560      | 1054840       | 353133599   | F1-2-2          | 7.213,00         |
| 800/400     | 640      | 1054839       | 353133792   | F1-2-2          | 6.248,00         |
| 800/500     | 680      | 1054841       | 353133794   | F1-2-2          | 7.337,00         |
| 800/600     | 790      | 1054875       | 353133795   | F1-2-2          | 7.532,00         |
| 1000/400    | 750      | 1054905       | 353133810   | F1-2-2          | 6.248,00         |
| 1000/500    | 790      | 1054906       | 353133812   | F1-2-2          | 7.532,00         |
| 1000/600    | 900      | 1054900       | 353133813   | F1-2-2          | 7.917,00         |
| 1000/800    | 940      | 1054876       | 353133818   | F1-2-2          | 9.404,00         |
| 1200/600    | 1030     | 1054901       | 353133854   | F1-2-2          | 8.371,00         |
| 1200/800    | 1070     | 1054903       | 353133856   | F1-2-2          | 9.530,00         |
| 1200/1000   | 1140     | 1054877       | 353133858   | F1-2-2          | 12.619,00        |
| 1400/800    | 1170     | 1054878       |             | F1-2-2          | Efter aftale     |
| 1400/1000   | 1240     | 1054879       |             | F1-2-2          | Efter aftale     |
| 1400/1200   | 950      | 1054880       |             | F1-2-2          | Efter aftale     |
| 1600/1000   | 1340     | 1054904       |             | F1-2-2          | Efter aftale     |
| 1600/1200   | 1050     | 1054881       |             | F1-2-2          | Efter aftale     |
| 1600/1400   | 1050     | 1054882       |             | F1-2-2          | Efter aftale     |
| 2000/1200   | 1250     | 1054883       |             | F1-2-2          | Efter aftale     |
| 2000/1400   | 1250     | 1054884       |             | F1-2-2          | Efter aftale     |
| 2000/1600   | 1250     | 1054885       |             | F1-2-2          | Efter aftale     |
| 2500/1400   | 1500     | 1054886       |             | F1-2-2          | Efter aftale     |
| 2500/1600   | 1500     | 1054887       |             | F1-2-2          | Efter aftale     |
| 2500/2000   | 1500     | 1054888       |             | F1-2-2          | Efter aftale     |

## Uponor underjordisk ventilationssystem - UVS

Prisliste januar 2019, ekskl. moms / ret til ændringer forbeholdes

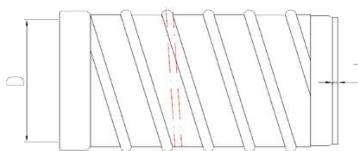

### Endebund

På dimensioner  $\varnothing 600$ - $\varnothing 2500$  påsvejses tæt endebund på rørene fra fabrikken.

På dimensioner fra  $\varnothing 200$ - $\varnothing 500$  kan endebund påsættes på byggepladsen.

Begge løsninger er 100% tætte og kan stå under grundvand uden risiko for lækage.

| D<br>mm | T<br>mm | Uponor<br>nr. | VVS-<br>nr. | Vare-<br>gruppe | Pris<br>Kr./stk. |
|---------|---------|---------------|-------------|-----------------|------------------|
| 200     | 15      | 1051482       | 353148200   | F1-2-1          | 338,00           |
| 250     | 15      | 1051483       | 353148250   | F1-2-1          | 530,00           |
| 315     | 15      | 1051484       | 353148315   | F1-2-1          | 758,00           |
| 400     | 15      | 1051485       | 353148405   | F1-2-1          | 1.444,00         |
| 500     | 15      | 1051486       | 353148412   | F1-2-1          | 1.898,00         |
| 600     | 20      | 1054989       | 353148415   | F1-2-2          | 3.612,00         |
| 800     | 20      | 1054990       | 353148440   | F1-2-2          | 4.771,00         |
| 1000    | 20      | 1054991       | 353148460   | F1-2-2          | 6.373,00         |
| 1200    | 30      | 1054992       | 353148475   | F1-2-2          | 7.792,00         |
| 1400    | 30      | 1054993       |             | F1-2-2          | Efter aftale     |
| 1600    | 30      | 1054994       |             | F1-2-2          | Efter aftale     |
| 2000    | 30      | 1054995       |             | F1-2-2          | Efter aftale     |
| 2500    | 30      | 1054996       |             | F1-2-2          | Efter aftale     |



### Uponor smøremiddel

Leveres i tube eller spand

| Vægt g<br>pr. pakning | Pakning | Antal pr.<br>karton | Uponor<br>nr. | VVS-<br>nr. | Vare-<br>gruppe | Pris<br>Kr./stk. |
|-----------------------|---------|---------------------|---------------|-------------|-----------------|------------------|
| 225                   | Tube    | 20                  | 1003501       |             | A1-3-3          | 103,00           |
| 1000                  | Spand   | 12                  | 1003502       | 061715008   | A1-3-3          | 189,00           |

# Uponor underjordisk ventilationssystem - UVS

Prisliste januar 2019, ekskl. moms / ret til ændringer forbeholdes

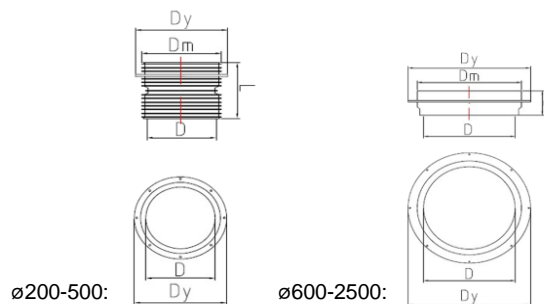
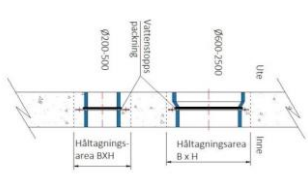
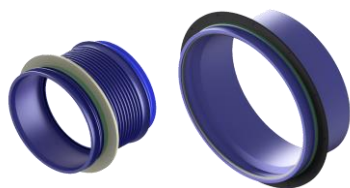

## Indstøbningsmuffe

Anvendes til gennemføring i betonfundament. Indstøbningsmuffen skaber en effektiv spærring mod vandindtrængning omkring ventilationsrøret. Indstøbningsmuffen kan leveres fra ø200-ø2500, og vandstoppakning indgår i indstøbningsmuffe. Muffe tilpasses normalt til 200-500 mm vægtykkelse til indmontering i kasseformer, men kan også fås længere, hvis ønsket.

| D<br>mm | Udv.<br>muffe<br>mm | Udv. støb-<br>ningskrave<br>mm | Areal* (BxH)<br>mm | Uponor<br>nr. | VVS-<br>nr. | Vare-<br>gruppe | Pris<br>Kr./stk. |
|---------|---------------------|--------------------------------|--------------------|---------------|-------------|-----------------|------------------|
| 200     | 224                 | 370                            | 420 x 420 *        | 1054867       | 353140200   | F1-2-1          | 1.285,00         |
| 250     | 277                 | 420                            | 470 x 470 *        | 1054868       | 353140250   | F1-2-1          | 1.738,00         |
| 315     | 346                 | 485                            | 535 x 535 *        | 1054869       | 353140315   | F1-2-1          | 2.126,00         |
| 400     | 488                 | 630                            | 680 x 680 *        | 1054870       | 353140405   | F1-2-1          | 3.158,00         |
| 500     | 605                 | 740                            | 790 x 790 *        | 1054871       | 353140412   | F1-2-1          | 4.192,00         |
| 600     | 723                 | 910                            | 960 x 960 *        | 1054907       | 353140415   | F1-2-2          | 5.350,00         |
| 800     | 955                 | 1140                           | 1190 x 1190 *      | 1054908       | 353140440   | F1-2-2          | 7.144,00         |
| 1000    | 1185                | 1370                           | 1420 x 1420 *      | 1054909       | 353140460   | F1-2-2          | 10.178,00        |
| 1200    | 1350                | 1550                           | 1600 x 1600 *      | 1054910       | 353140475   | F1-2-2          | 13.006,00        |
| 1400    | 1560                | 1760                           | 1810 x 1810 *      | 1054911       | 353140485   | F1-2-2          | 14.936,00        |
| 1600    | 1760                | 1960                           | 2010 x 2010 *      | 1054912       | 353140495   | F1-2-2          | 17.072,00        |
| 2000    | 2170                | 2370                           | 2420 x 2420 *      | 1054913       | 353140498   | F1-2-2          | 24.601,00        |
| 2500    | 2720                | 2920                           | 2970 x 2970 *      | 1054914       | 353140499   | F1-2-2          | 29.370,00        |

\* Areal baseret på et spillerum på totalt 50 mm (25 mm på hver side af kraven). Det bør kontrolleres, om dette er tilstrækkeligt til en sikker fyldning af betonen.

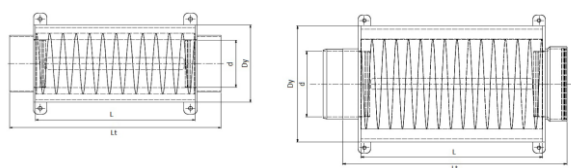
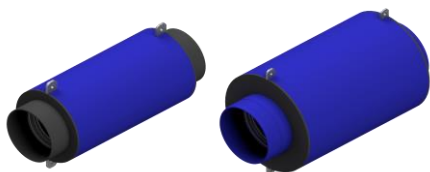

## Lyddæmpere

I de tilfælde hvor der ikke er plads til lyddæmper inde i bygningen, kan der anvendes Uponor UVS lyddæmpere. Lyddæmperne leveres indkapslet og kan installeres direkte i jorden. Dæmpningen forhindrer effektivt gengivelse af lyd.

| D<br>mm | Udv. mål<br>mm | Længder |      | Uponor<br>nr. | VVS-<br>nr. | Vare-<br>gruppe | Pris<br>Kr./stk. |
|---------|----------------|---------|------|---------------|-------------|-----------------|------------------|
|         |                | L       | Lt   |               |             |                 |                  |
| 200     | 450            | 1200    | 1560 | 1054918       | 353141200   | F1-2-1          | 7.337,00         |
| 250     | 450            | 1200    | 1600 | 1054919       | 353141250   | F1-2-1          | 8.178,00         |
| 315     | 560            | 1200    | 1615 | 1054920       | 353141315   | F1-2-1          | 11.460,00        |
| 400     | 680            | 1200    | 1590 | 1054921       | 353141405   | F1-2-1          | 15.584,00        |
| 500     | 780            | 1200    | 1660 | 1054922       | 353141412   | F1-2-2          | 20.989,00        |
| 600     | 880            | 1500    | 2160 | 1054997       | 353141415   | F1-2-2          | 35.424,00        |
| 800     | 1090           | 1500    | 2240 | 1054998       | 353141440   | F1-2-2          | 43.657,00        |
| 1000    | 1300           | 1500    | 2380 | 1054999       | 353141460   | F1-2-2          | 57.309,00        |
| 1200    | 1500           | 1500    | 2000 | 1055000       | 353141475   | F1-2-2          | 65.554,00        |

\* Kontakt Uponor for andre længder og dimensioner.

## Uponor underjordisk ventilationssystem - UVS

Prisliste januar 2019, ekskl. moms / ret til ændringer forbeholdes

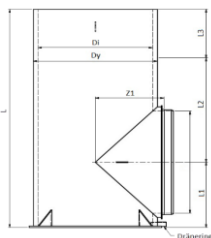

### Indsugnings- og udblæsningstårne

Tårnet er produceret i PE-materiale og har en næsten glat yderside. Tårn leveres sammen med indsugnings- og udblæsningshætter i aluminium. Hætterne kan ligeledes leveres lakerede i valgfri, specificeret RAL-farve. Ventilationshætten kan desuden leveres med varmekabler.

Indsugningshætten har et trykfald på mellem 3-8 Pa. Udblæsningshætten har et trykfald på 3-5 Pa under forudsætning af, at anbefalingerne for luftmængder i tabellen følges.

| D<br>mm | Udv.<br>mm | L<br>mm | L1<br>mm | L2<br>mm | L3<br>mm | Z1<br>mm | Anbefalet max. luft   |                      | Uponor<br>nr. | Vare-<br>gruppe | Pris<br>Kr./stk. |
|---------|------------|---------|----------|----------|----------|----------|-----------------------|----------------------|---------------|-----------------|------------------|
|         |            |         |          |          |          |          | Ind m <sup>3</sup> /h | Ud m <sup>3</sup> /h |               |                 |                  |
| 600     | 652        | 3250    | 550      | 700      | 2000     | 500      | 4200                  | 7000                 | 1055017       | F1-2-2          | 19.388,00        |
| 800     | 869        | 3550    | 650      | 900      | 2000     | 600      | 7000                  | 12500                | 1055018       | F1-2-2          | 26.532,00        |
| 1000    | 1092       | 3800    | 800      | 1000     | 2000     | 750      | 11000                 | 20000                | 1055019       | F1-2-2          | 31.427,00        |
| 1200    | 1304       | 4000    | 900      | 1100     | 2000     | 850      | 16500                 | 28000                | 1055020       | F1-2-2          | 42.113,00        |
| 1400    | 1530       | 4200    | 1000     | 1200     | 2000     | 950      | 21000                 | 39000                | 1055021       | F1-2-2          | 64.135,00        |
| 1600    | 1735       | 4500    | 1200     | 1300     | 2000     | 1050     | 29000                 | 50000                | 1055022       | F1-2-2          | 75.083,00        |
| 2000    | 2182       | 4900    | 1400     | 1500     | 2000     | 1250     | 45000                 | 80000                | 1055023       | F1-2-2          | 104.452,00       |
| 2500    | 2724       | 5350    | 1600     | 1750     | 2000     | 1500     | 70000                 | 120000               | 1055024       | F1-2-2          | 139.228,00       |



### Ventilations indsugningshætte

Hætten er produceret i aluminium

| D<br>mm | Lakeret /<br>Ulakeret | Effekt<br>W | Max. luft-<br>mængde<br>m <sup>3</sup> /h (4m/s) | H<br>mm | Uponor<br>nr. | VVS-<br>nr. | Vare-<br>gruppe | Pris<br>Kr./stk. |
|---------|-----------------------|-------------|--|---------|---------------|-------------|-----------------|------------------|
| 600     | Ulakeret              |             | 4200   | 410     | 1095179       |             | F1-2-2          | 12.176,00        |
| 800     | Ulakeret              |             | 7000   | 504     | 1095180       |             | F1-2-2          | 23.250,00        |
| 1000    | Ulakeret              |             | 11000  | 567     | 1095181       |             | F1-2-2          | 30.007,00        |
| 1200    | Ulakeret              |             | 16500  | 693     | 1095182       |             | F1-2-2          | 42.374,00        |
| 1400    | Ulakeret              |             | 21000  | 788     | 1095183       |             | F1-2-2          | 49.132,00        |
| 1600    | Ulakeret              |             | 29000  | 819     | 1095184       |             | F1-2-2          | 65.554,00        |
| 2000    | Ulakeret              |             | 45000  | 1103    | 1095185       |             | F1-2-2          | 84.611,00        |
| 2500    | Ulakeret              |             | 70000  | 1355    | 1095186       |             | F1-2-2          | 102.385,00       |
| 600     | Lakeret               |             | 4200   | 410     | 1095187       |             | F1-2-2          | 13.777,00        |
| 800     | Lakeret               |             | 7000   | 504     | 1095188       |             | F1-2-2          | 25.249,00        |
| 1000    | Lakeret               |             | 11000  | 567     | 1095189       |             | F1-2-2          | 33.231,00        |
| 1200    | Lakeret               |             | 16500  | 693     | 1095190       |             | F1-2-2          | 45.077,00        |
| 1400    | Lakeret               |             | 21000  | 788     | 1095191       |             | F1-2-2          | 61.431,00        |
| 1600    | Lakeret               |             | 29000  | 819     | 1095192       |             | F1-2-2          | 72.379,00        |
| 2000    | Lakeret               |             | 45000  | 1103    | 1095193       |             | F1-2-2          | 94.810,00        |
| 2500    | Lakeret               |             | 70000  | 1355    | 1095194       |             | F1-2-2          | 132.401,00       |
| 600 *   | Varmekabel            | 468         |  |         | 1054973       | 353146415   | F1-2-2          | 5.737,00         |
| 800 *   | Varmekabel            | 738         |  |         | 1054974       | 353146440   | F1-2-2          | 7.668,00         |
| 1000 *  | Varmekabel            | 1044        |  |         | 1054975       | 353146460   | F1-2-2          | 10.495,00        |
| 1200 *  | Varmekabel            | 1530        |  |         | 1054976       | 353146475   | F1-2-2          | 17.514,00        |
| 1400 *  | Varmekabel            | 2052        |  |         | 1054977       | 353146485   | F1-2-2          | 24.601,00        |
| 1600 *  | Varmekabel            | 2394        |  |         | 1054978       | 353146495   | F1-2-2          | 30.007,00        |
| 2000 *  | Varmekabel            | 3996        |  |         | 1054979       |             | F1-2-2          | 36.833,00        |
| 2500 *  | Varmekabel            | 6102        |  |         | 1054980       |             | F1-2-2          | 42.249,00        |

\* Varmekabel er et tilvalg til den kombinerede ventilationshætte



## Uponor underjordisk ventilationssystem - UVS

Prisliste januar 2019, ekskl. moms / ret til ændringer forbeholdes



### Ventilations udblæsningshætte

Hætten er produceret i aluminium

| D<br>mm | Lakeret /<br>Ulakeret | Max. luft-<br>mængde<br>m <sup>3</sup> /h (4m/s) | H<br>mm | Uponor<br>nr. | Vare-<br>gruppe | Pris<br>Kr./stk. |
|---------|-----------------------|--|---------|---------------|-----------------|------------------|
| 600     | Ulakeret              | 7000   | 410     | 1095195       | F1-2-2          | 5.214,00         |
| 800     | Ulakeret              | 12500  | 504     | 1095196       | F1-2-2          | 6.441,00         |
| 1000    | Ulakeret              | 20000  | 567     | 1095197       | F1-2-2          | 8.053,00         |
| 1200    | Ulakeret              | 28000  | 693     | 1095199       | F1-2-2          | 9.666,00         |
| 1400    | Ulakeret              | 39000  | 788     | 1095201       | F1-2-2          | 11.336,00        |
| 1600    | Ulakeret              | 50000  | 819     | 1095203       | F1-2-2          | 12.948,00        |
| 2000    | Ulakeret              | 80000  | 1103    | 1095204       | F1-2-2          | 14.494,00        |
| 2500    | Ulakeret              | 120000   | 1355    | 1095205       | F1-2-2          | 16.355,00        |
| 600     | Lakeret               | 7000   | 410     | 1095206       | F1-2-2          | 5.862,00         |
| 800     | Lakeret               | 12500  | 504     | 1095207       | F1-2-2          | 7.406,00         |
| 1000    | Lakeret               | 20000  | 567     | 1095208       | F1-2-2          | 9.144,00         |
| 1200    | Lakeret               | 28000  | 693     | 1095209       | F1-2-2          | 11.074,00        |
| 1400    | Lakeret               | 39000  | 788     | 1095210       | F1-2-2          | 12.812,00        |
| 1600    | Lakeret               | 50000  | 819     | 1095211       | F1-2-2          | 14.810,00        |
| 2000    | Lakeret               | 80000  | 1103    | 1054971       | F1-2-2          | 16.492,00        |
| 2500    | Lakeret               | 120000   | 1355    | 1095213       | F1-2-2          | 18.673,00        |

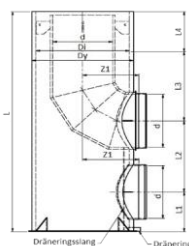

### Kombineret tårn

Hastighed for luften fra tårnet er 7 m/s

| D<br>mm | Udv.<br>mm | L<br>mm | L1<br>mm | L2<br>mm | L3<br>mm | L4<br>mm | Z1<br>mm | d<br>mm | Max. luft<br>m <sup>3</sup> /h | Uponor<br>nr. | VVS-<br>nr. | Vare-<br>gruppe | Pris<br>Kr./stk. |
|---------|------------|---------|----------|----------|----------|----------|----------|---------|--------------------------------|---------------|-------------|-----------------|------------------|
| 600     | 652        | 3950    | 450      | 800      | 700      | 2000     | 500      | 400     | 3200                           | 1054923       | 353143415   | F1-2-2          | 28.655,00        |
| 800     | 869        | 4150    | 500      | 900      | 750      | 2000     | 600      | 500     | 5000                           | 1054924       | 353143440   | F1-2-2          | 40.251,00        |
| 1000    | 1092       | 4350    | 550      | 1000     | 800      | 2000     | 750      | 600     | 7000                           | 1054925       | 353143460   | F1-2-2          | 50.483,00        |
| 1200    | 1304       | 4350    | 550      | 1000     | 800      | 2000     | 850      | 600     | 8000                           | 1054926       | 353143475   | F1-2-2          | 58.024,00        |
| 1400    | 1530       | 4800    | 650      | 1250     | 900      | 2000     | 950      | 800     | 13000                          | 1054927       | 353143485   | F1-2-2          | 87.325,00        |
| 1600    | 1735       | 5350    | 850      | 1500     | 1000     | 2000     | 1050     | 1000    | 20000                          | 1054928       | 353143495   | F1-2-2          | 111.914,00       |
| 2000    | 2182       | 5650    | 900      | 1650     | 1100     | 2000     | 1250     | 1200    | 29000                          | 1054929       | 353143498   | F1-2-2          | 150.176,00       |
| 2500    | 2724       | 6650    | 1200     | 2150     | 1300     | 2000     | 1500     | 1600    | 50000                          | 1054930       | 353143499   | F1-2-2          | 241.599,00       |

## Uponor underjordisk ventilationssystem - UVS

Prisliste januar 2019, ekskl. moms / ret til ændringer forbeholdes

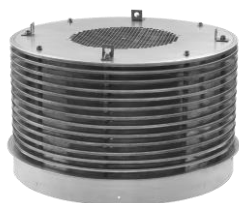

### Kombineret ventilationshætte

Til ind sugning og/eller udblæsning. Kombihætten har et trykfald på 3-8 Pa, hvis anbefalinger følges.

| D<br>mm | Lakeret /<br>Ulakeret | Effekt<br>W | Max. luft-<br>mængde<br>m <sup>3</sup> /h (4m/s) | H<br>mm | Uponor<br>nr. | VVS-<br>nr. | Vare-<br>gruppe | Pris<br>Kr./stk. |
|---------|-----------------------|-------------|--|---------|---------------|-------------|-----------------|------------------|
| 600     | Ulakeret              |             | 3200   | 410     | 1095214       | 353147415   | F1-2-2          | 19.126,00        |
| 800     | Ulakeret              |             | 5000   | 504     | 1095215       | 353147440   | F1-2-2          | 30.972,00        |
| 1000    | Ulakeret              |             | 7000   | 567     | 1095216       | 353147460   | F1-2-2          | 40.580,00        |
| 1200    | Ulakeret              |             | 8000   | 693     | 1095217       | 353147475   | F1-2-2          | 56.150,00        |
| 1400    | Ulakeret              |             | 13000  | 788     | 1095218       | 353147485   | F1-2-2          | 72.392,00        |
| 1600    | Ulakeret              |             | 20000  | 819     | 1095219       | 353147495   | F1-2-2          | 85.066,00        |
| 2000    | Ulakeret              |             | 29000  | 945     | 1095220       | 353147498   | F1-2-2          | 108.859,00       |
| 2500    | Ulakeret              |             | 50000  | 1103    | 1095221       |             | F1-2-2          | 120.135,00       |
| 600     | Lakeret               |             | 3200   | 410     | 1095222       |             | F1-2-2          | 20.061,00        |
| 800     | Lakeret               |             | 5000   | 504     | 1095223       |             | F1-2-2          | 31.953,00        |
| 1000    | Lakeret               |             | 7000   | 567     | 1095224       |             | F1-2-2          | 37.021,00        |
| 1200    | Lakeret               |             | 8000   | 693     | 1095225       |             | F1-2-2          | 57.082,00        |
| 1400    | Lakeret               |             | 13000  | 788     | 1095226       |             | F1-2-2          | 74.925,00        |
| 1600    | Lakeret               |             | 20000  | 819     | 1095227       |             | F1-2-2          | 86.685,00        |
| 2000    | Lakeret               |             | 29000  | 945     | 1095228       |             | F1-2-2          | 111.584,00       |
| 2500    | Lakeret               |             | 50000  | 1103    | 1095229       |             | F1-2-2          | 132.572,00       |
| 600 *   | Varmekabel            | 468         |  |         | 1054973       | 353146415   | F1-2-2          | 5.737,00         |
| 800 *   | Varmekabel            | 738         |  |         | 1054974       | 353146440   | F1-2-2          | 7.668,00         |
| 1000 *  | Varmekabel            | 1044        |  |         | 1054975       | 353146460   | F1-2-2          | 10.495,00        |
| 1200 *  | Varmekabel            | 1530        |  |         | 1054976       | 353146475   | F1-2-2          | 17.514,00        |
| 1400 *  | Varmekabel            | 2052        |  |         | 1054977       | 353146485   | F1-2-2          | 24.601,00        |
| 1600 *  | Varmekabel            | 2394        |  |         | 1054978       | 353146495   | F1-2-2          | 30.007,00        |
| 2000 *  | Varmekabel            | 3420        |  |         | 1054979       |             | F1-2-2          | 36.833,00        |
| 2500 *  | Varmekabel            | 4986        |  |         | 1054980       |             | F1-2-2          | 42.249,00        |

\* Varmekabel er et tilvalg til den kombinerede ventilationshætte